

60mm sq.

San Ace 60

15mm thick (GA type), 15mm thick
 20mm thick (GA type), 20mm thick
 25mm thick (S type), 25mm thick (G type)
 25mm thick, 25mm thick (San Cooler)
 38mm thick (GA type), 38mm thick (GV type)
 38mm thick (G type)



Model no. 109P0612K701 is not certified.

General Specifications

- Material Frame: Plastics (Flammability: UL94V-0),
 Impeller: Plastics (Flammability: UL94V-1)
- Expected Life Refer to specifications (L10:Survival rate:90% at 60°C ,
 rated voltage, and continuously run in a free air state)
- Lead Wire ⊕red ⊖black or blue (Sensor) yellow
- Storage Temperature -30°C to +70°C (Non-condensing)

60×60×15mm [Mass : 60g]

Specifications

The following nos. **have pulse sensors and ribs.**

Model No.	Rated Voltage [V]	Operating Voltage Range [V]	Rated Current [A]	Rated Input [W]	Rated Speed [min ⁻¹]	Max. Air Flow [m ³ /min] [CFM]	Max. Static Pressure [Pa] [inchH ₂ O]	SPL [dB(A)]	Operating Temperature [°C]	Expected Life [h]	
109P0605H701	5	4.5 to 5.5	0.26	1.30	4,100	0.40 14.1	38.2 0.153	32	-20 to +70	60,000	
109P0605M701			0.15	0.75	3,100	0.30 10.6	22.6 0.091	25			
109P0612K701	12	10.2 to 13.8	0.26	3.12	6,500	0.62 21.9	99.3 0.399	45	-20 to +60	40,000	
109P0612S701			0.15	1.80	5,000	0.48 17.0	58.8 0.236	36			
109P0612H701		7 to 13.8	0.09	1.08	4,100	0.40 14.1	38.2 0.153	32		-20 to +70	60,000
109P0612M701		10.2 to 13.8	0.07	0.84	3,100	0.30 10.6	22.6 0.091	25			
109P0612B701		10.2 to 13.8	0.05	0.6	2,200	0.21 7.42	11.7 0.047	21		-20 to +60	40,000
109P0624J701		14 to 27.6	0.14	3.36	6,200	0.61 21.5	86.5 0.347	44			
109P0624S701	14 to 27.6	0.08	1.92	5,000	0.48 16.9	58.8 0.236	36	-20 to +70	60,000		
109P0624H701	20.4 to 27.6	0.06	1.44	4,100	0.40 14.1	38.2 0.153	32				
109P0624M701	20.4 to 27.6	0.04	0.96	3,100	0.30 10.6	22.6 0.091	25				

Available options: ⇒ **Without Sensor**

Please inquire as the availability of these functions depend on the model. ⇒ **Lock Sensor**

Dimensions (Unit : mm)

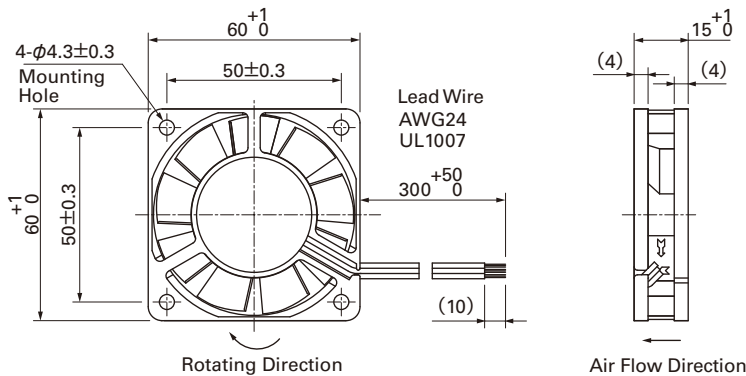

Reference dimension of mounting holes and vent opening (Unit : mm)

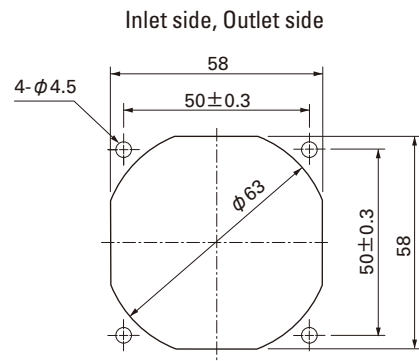

Options (Unit : mm)

Finger guards

Model : 109-139E Surface treatment : Nickel-chrome plating (silver)
 : 109-139H : Cation electropainting (black)

Inlet side, Outlet side

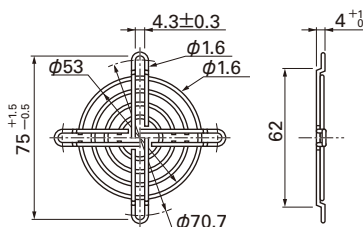

Resin finger guards

Model : 109-1003G

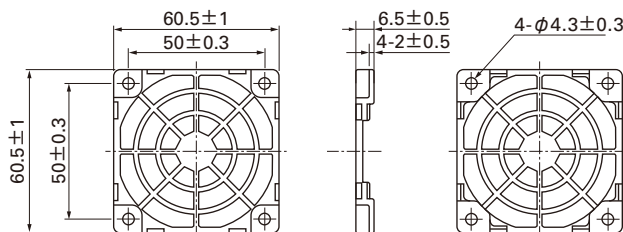

Options (Unit : mm)

Resin filter kits

Model : 109-1003F13 (13PPI), 109-1003F20 (20PPI)
 : 109-1003F30 (30PPI), 109-1003F40 (40PPI)

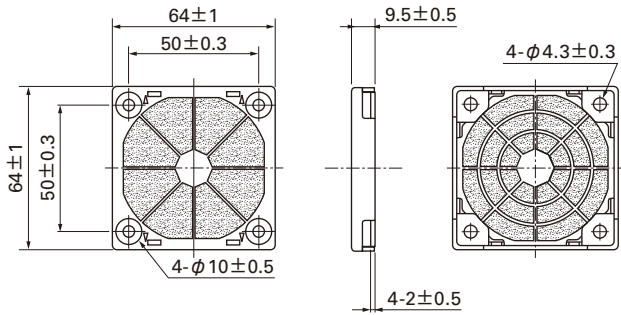

Air Flow - Static Pressure Characteristics

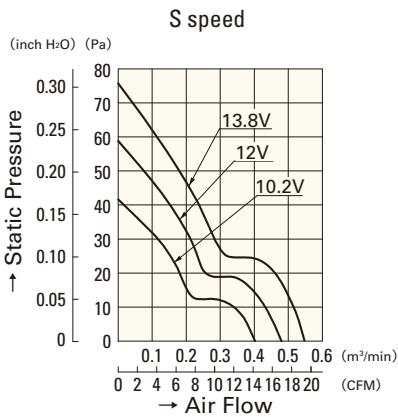

109P0612S701

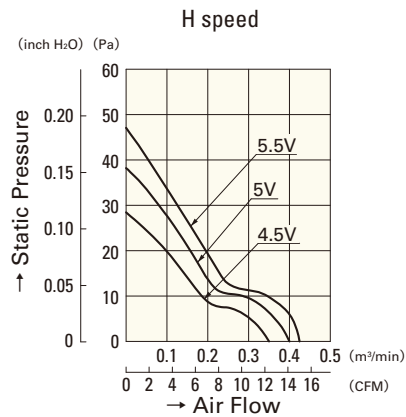

109P0605H701

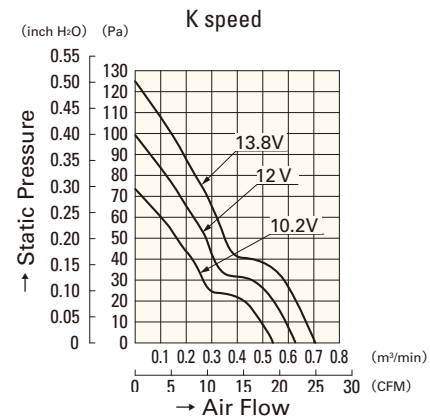

109P0612K701

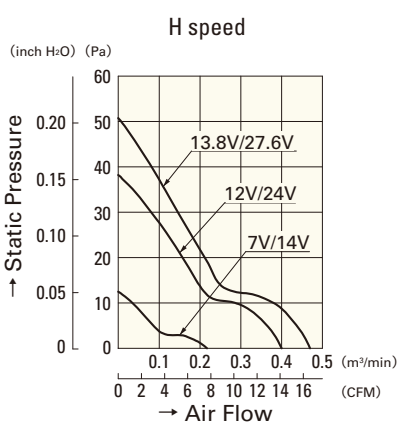

109P0612H701
109P0624H701

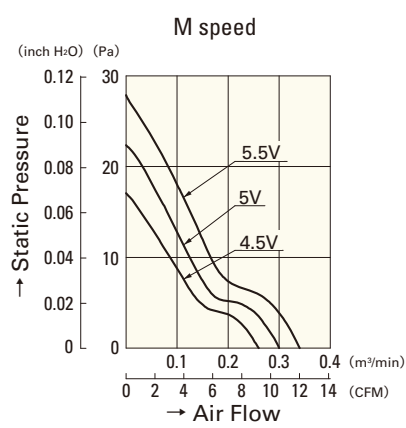

109P0605M701

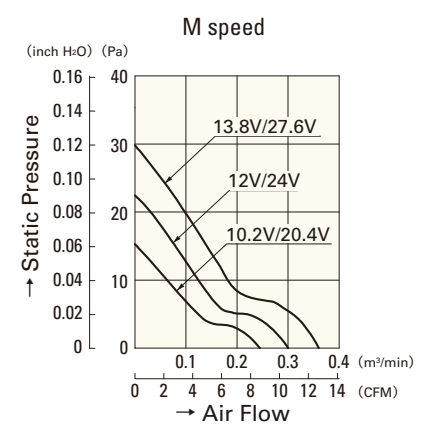

109P0612M701
109P0624M701

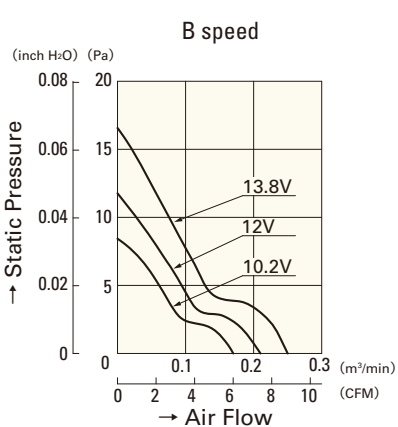

109P0612B701

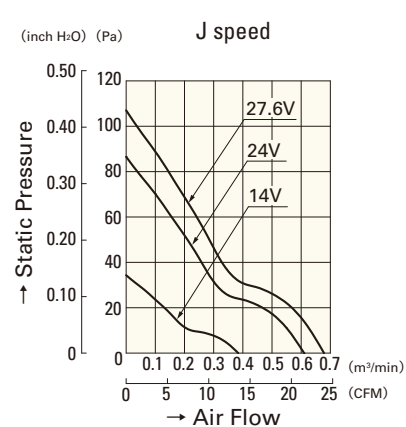

109P0624J701

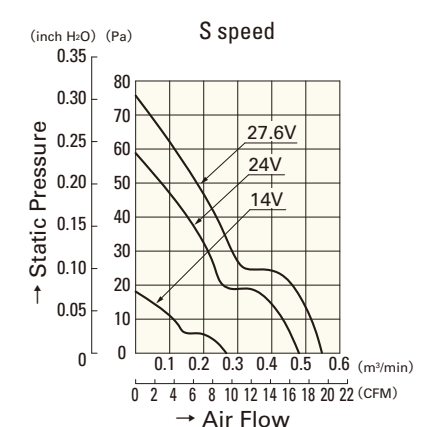

109P0624S701